

19" PROlineB Series Wall Mounting Cabinets



19" PROlineB Series

Wall Mounting Cabinets

Features:

PROlineB Series Networking Enclosures / Cabinets, designed for customer friendly product assembly and superior Logistics advantages in terms of shipping costs.

Superior load performance tested with 2 times higher load than nominal weight load capacity, nominal weight load is 50 kg, tested with 100 kg on wall. Therefore no any problem of carrying heavy telecom equipments, UPS and batteries rather than standard network technology equipments such as switches, patch panels and cables.

High technology fully automated industry produced range offers the 600x450 mm, 600x600 mm PROlineB Series, which are available in 7 heights from 4U to 21U. Each cabinet is supplied as standard with a glass front door, removable side panels with a special hidden spring loaded pin system of which the side panels are secure. Side panels can be opened by an authorized person after opening the front door with the key.

The wide product height portfolio meets any U requirement in infrastructure needs. **PROlineB** series have a professional technical but aesthetic look smoked and secure glass front door; the product range attracts the attention with the mostly environmentally fit and selected color of RAL 9005 Black, and RAL 7035 Light Grey with fine wrinkle soft touch paint.

Completely standard and stocked product portfolio, single piece flat packed delivery, assembled delivery option. One set: 4 pieces of 19" equipment mounting rails are included in the shipment configuration. D450 mm and D600 mm cabinets are included. Front rails are adjustable in depth and rear rails are fixed on the rear frame of cabinet.

PROlineB Series product range offers optimal panel mounting size and a variety of accessories for all user expectations.

PROlineB Series have Nano Tech-nology pre-treatment process, Bonderite/Henkel Chemicals applied before Epoxy Powder coating application, 80-120 micron thickness, 500 +hours of salt spray testing performed as per ASTM B 117 and EN ISO 9227, in means of very high corrosion resistance.

Load Capacity: Up to 100 kg.



19" PROlineB Series

Wall Mounting Cabinets

Compliance with standards:

- With the EN 12150-1 standard antistatic, smoked tempered safety glass 4,0 mm front glass door.
- Round quarter turn lock which is compatible with DIN 1743, DIN 53571, RoHS.
- EN 60297- Mechanical constructions for electronic devices. mechanical constructions (19 inch series) with standard universal 482,6 mm profiles
- EN 60917- Modular layout for development of mechanical constructions in electronic equipment applications.
- EN 61587-1 For electronic devices inner usage mechanic construction cabinets, bottom shelves, cases, IEC 60917 and IEC 60297 series tests, Chapter 1, environmental conditions, test setup and security rules.
- EIA/ ECA-310 (D/E) 19" 482,6 mm and U 44,45 mm Height Sizing
- Climatic and environment: EN 61587-1/4.2, IEC 60068-2-1, IEC 60068-2-2, IEC 60068-2-30
- Static Mechanical Load Lifting: EN 61587-1/5.2.1
- Static Mechanical Load Stiffness: EN 61587-1/5.2.2
- Dynamic mechanical load vibration and shock, impact: EN 61587-1/5.3.1, EN 61587-1/5.3.3, IEC 60068-2-6, IEC 60068-2-27
- Grounding: EN 61587-1/6.2
- Fireproofing: EN 61587-1/6.3
- IP protection class (IP code): IP20, EN 61587-1/6.4
- The powder paint used is non-flammable and has a flame-retardant resistant according to TS EN 13501-1 + A1 standard
- TS EN ISO 9227 corrosion tests, salt spraying tests, TS EN ISO 2409 paints and varnishes, cross cutting test, TS 2311 EN ISO2178 above magnetic metals non-magnetic covering, measuring covering thickness, magnetic method
- 2011/65/EU- regulation of hazardous material restriction/ RoHS suitability
- TS EN 60950-1 information technology devices, Security- Chapter 1
- General rules- CE suitability
- Sheet steel: DIN 934, DIN 985, DIN 933 - EN ISO 2081 metallic and other inorganic coverings covered above iron or steel with the additional process electrolytic zinc covering standards

Production Facility Standards

- ISO 9001- Quality Control System
- ISO 14001- Environmental Management System

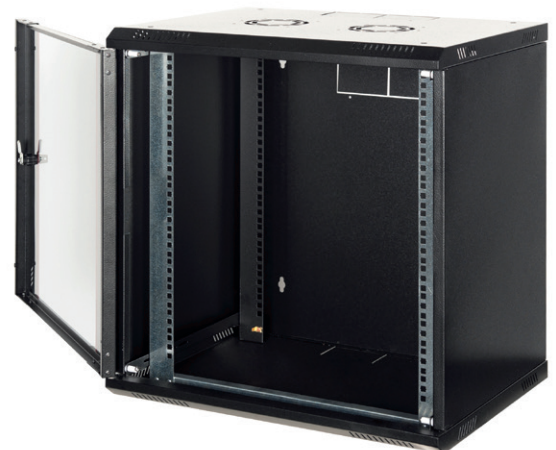
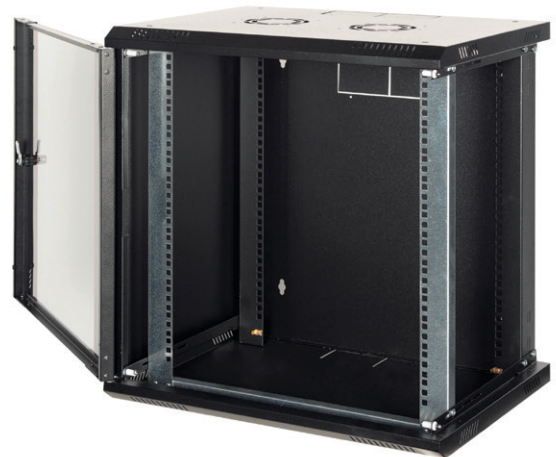

19" PROlineB Series

Wall Mounting Cabinets

Technical Drawings

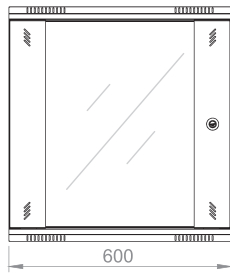

Front view

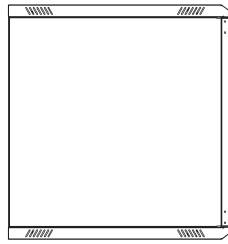

Side view

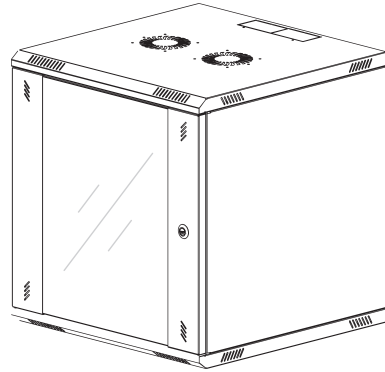

Isometric view

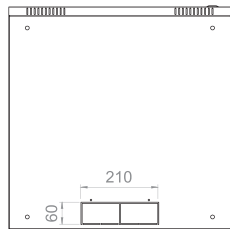

Bottom view

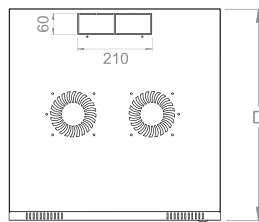

Top view

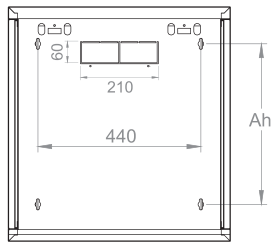

Rear view

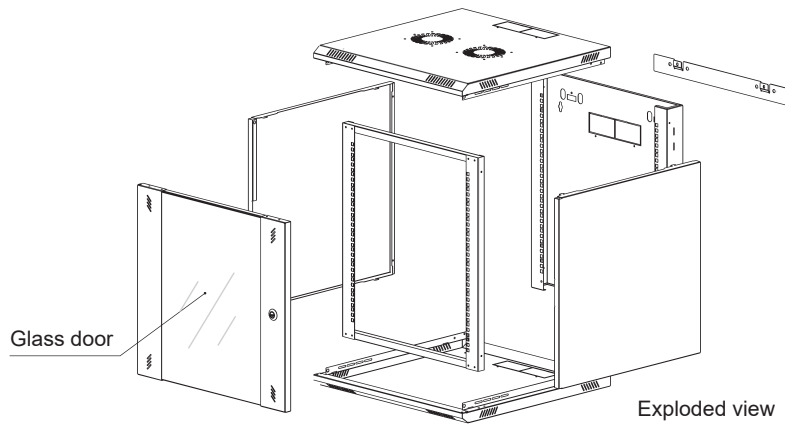

Exploded view

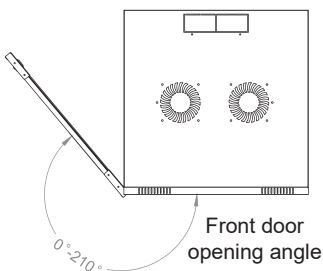

Front door opening angle

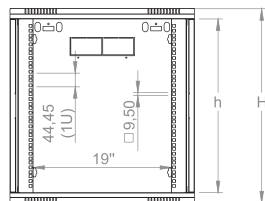

Dimensions in width and height

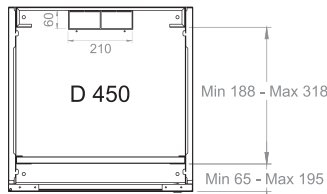

Max. / Min Equipment mounting distance (450)

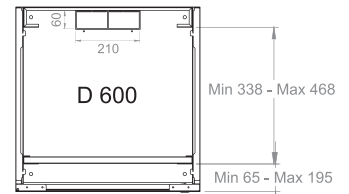

Max. / Min Equipment mounting distance (600)

U	Ah	h	H	D
4U	78	210	278	450-600
6U	167	299	367	450-600
9U	301	432	500	450-600
12U	434	565	633	450-600
15U	567	698	766	450-600
18U	700	832	900	450-600
21U	834	934	1033	450-600

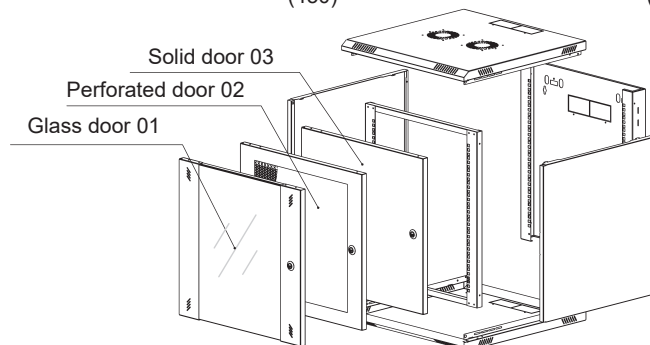

FRONT DOOR FD TYPES (00-01-02-03)

- (00) - No Front door
- (01) - Glass Door
- (02) - Perforated Door
- (03) - Solid Door

19" PROlineB Series

Wall Mounting Cabinets

Height and Depth Informations

Part Definition	Material Quality	Material Thickness (mm)	Shipment Configuration
Main Body (Structure)	DIN EN 10130-DC-01-6112 CRS	0,8 mm	1
Front Door	EN 12150-1 Temperli Cam	4 mm	1
19" Equipment Mounting Rails	DIN EN 10130-DC-01-6112 CRS	1,2 mm	2
Rear Body Frame	DIN EN 10130-DC-01-6112 CRS	1 mm	1
Side Panels	DIN EN 10130-DC-01-6112 CRS	0,8 mm	2
Wall Easy Hanging Bracket	DIN EN 10130-DC-01-6112 CRS	1,5 mm	1

19" ProlineB Series Wall Mounting Cabinet W600 mm D450 mm								
*Product Code	Series	Description	Product Size WxDxH mm	Net Weight kg.	Assembled Packing Box Sizes WxDxH mm	Assembled Packed Weight kg.	Flat Packed Box Sizes WxDxH mm	Flat Packed Weight kg.
LN-PRB-04U6045-CC-A/F-FD	PROlineB Series	04U 19" W600 x D450 mm ProlineB Series Wall Mounting Cabinet	600x450x278	11,4	645x515x292	13,4	615x478x125	13
LN-PRB-06U6045-CC-A/F-FD	PROlineB Series	06U 19" W600 x D450 mm ProlineB Series Wall Mounting Cabinet	600x450x367	13	645x515x382	15	615x482x130	14,6
LN-PRB-09U6045-CC-A/F-FD	PROlineB Series	09U 19" W600 x D450 mm ProlineB Series Wall Mounting Cabinet	600x450x500	15,8	645x515x514	17,8	615x582x135	17,3
LN-PRB-12U6045-CC-A/F-FD	PROlineB Series	12U 19" W600 x D450 mm ProlineB Series Wall Mounting Cabinet	600x450x633	18,8	645x515x677	21,1	645x585x165	19,7
LN-PRB-15U6045-CC-A/F-FD	PROlineB Series	15U 19" W600 x D450 mm ProlineB Series Wall Mounting Cabinet	600x450x767	21,6	645x515x791	24,1	782x630x165	23,7
LN-PRB-18U6045-CC-A/F-FD	PROlineB Series	18U 19" W600 x D450 mm ProlineB Series Wall Mounting Cabinet	600x450x900	24,2	645x515x914	26,7	915x630x165	26,3
LN-PRB-21U6045-CC-A/F-FD	PROlineB Series	21U 19" W600 x D450 mm ProlineB Series Wall Mounting Cabinet	600x450x1033	26,8	645x515x1047	29,8	1040x630x165	29,4

* A/F notation is related to packing definition, if assembled required please keep A, if flat pack required please keep F on the part number extension.

FD is front door selection, 00 no door, 01 glass door, 02 perforated front door, 03 solid metal door.

CC= Color codification, replace CC with BL for Black RAL 9005 Color and replace CC with LG for Light Grey RAL 7035 Color.

19" ProlineB Series Wall Mounting Cabinet W600 mm D600 mm								
*Product Code	Series	Description	Product Size WxDxH mm	Net Weight kg.	Assembled Packing Box Sizes WxDxH mm	Assembled Packed Weight kg.	Flat Packed Box Sizes WxDxH mm	Flat Packed Weight kg.
LN-PRB-04U6060-CC-A/F-FD	PROlineB Series	04U 19" W600 x D600 mm ProlineB Series Wall Mounting Cabinet	600x600x278	13,4	635x655x292	15,8	632x615x120	15,4
LN-PRB-06U6060-CC-A/F-FD	PROlineB Series	06U 19" W600 x D600 mm ProlineB Series Wall Mounting Cabinet	600x600x367	15,4	635x655x382	17,8	632x615x120	17,4
LN-PRB-09U6060-CC-A/F-FD	PROlineB Series	09U 19" W600 x D600 mm ProlineB Series Wall Mounting Cabinet	600x600x500	18	635x655x514	20,4	632x615x125	20
LN-PRB-12U6060-CC-A/F-FD	PROlineB Series	12U 19" W600 x D600 mm ProlineB Series Wall Mounting Cabinet	600x600x633	21,8	635x655x677	24,5	645x632x190	24,1
LN-PRB-15U6060-CC-A/F-FD	PROlineB Series	15U 19" W600 x D600 mm ProlineB Series Wall Mounting Cabinet	600x600x767	26,2	635x655x791	28,9	1220x632x197	28,5
LN-PRB-18U6060-CC-A/F-FD	PROlineB Series	18U 19" W600 x D600 mm ProlineB Series Wall Mounting Cabinet	600x600x900	27,6	635x655x914	30,3	1220x632x197	29,9
LN-PRB-21U6060-CC-A/F-FD	PROlineB Series	21U 19" W600 x D600 mm ProlineB Series Wall Mounting Cabinet	600x600x1033	30,6	635x655x1047	33,6	1220x632x197	33,2

* A/F notation is related to packing definition, if assembled required please keep A, if flat pack required please keep F on the part number extension.

FD is front door selection, 00 no door, 01 glass door, 02 perforated front door, 03 solid metal door.

CC= Color codification, replace CC with BL for Black RAL 9005 Color and replace CC with LG for Light Grey RAL 7035 Color.

19" PROlineB Series

Wall Mounting Cabinets

Features

SUPERIOR LOGISTICS COST SAVINGS WITH FLAT PACK



EASY & SHORT ASSEMBLY
Total 12 Screw- Assembly
Time: less than 2 mins



QUICK FIT and QUICK LIFT OFF SIDE PANELS



PULL & RELEASE PINS WHICH LOCK QUICK FIT SIDE PANELS PROVIDES SECURITY
Accessible by the authorized person only when the front door key lock is opened.

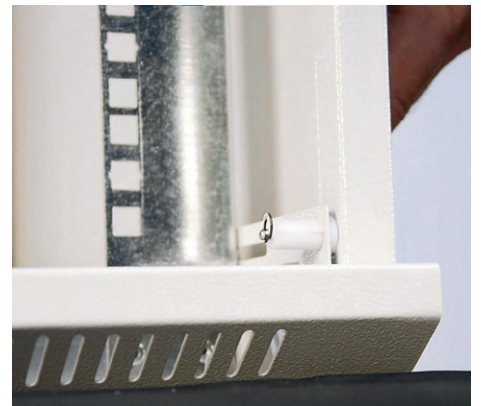

QUICK INSTALL and QUICK RELEASE FRONT DOOR HINGE PINS

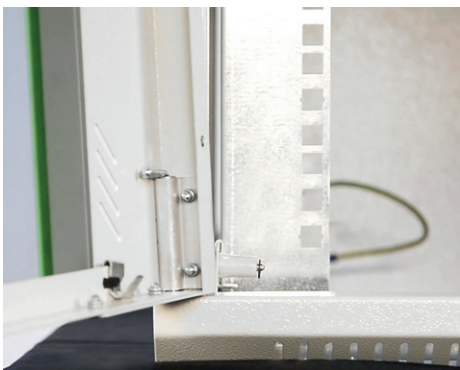

EASY WALL FIXING
Only 1 Technician needed



19" PROlineB Series

Wall Mounting Cabinets

Features

MULTIPLE CABLE ENTRY OPTIONS EASY BEND CONCEPT

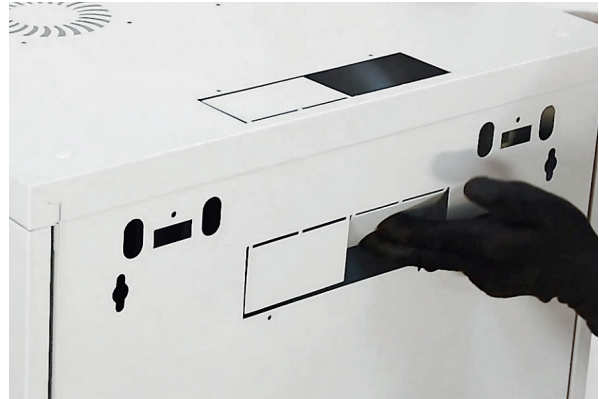
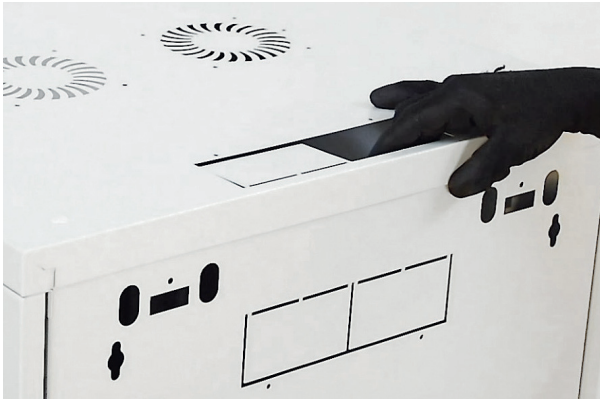

19" RAILS ARE 4 PCS in STANDARD FOR BOTH D450 and D600 mm CABINETS
2 ADJUSTABLE in FRONT 2 FIXED ON REAR WALL FRAME MODULE

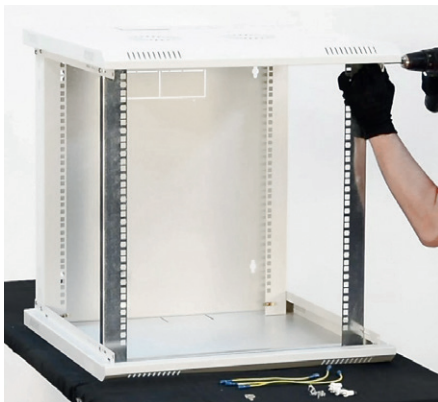

QUICK SNAP FIXING GROUNDING TERMINALS and PLUG-IN GROUNDING CABLES ARE OPTIONAL



19" PROlineB Series

Wall Mounting Cabinets

Accessories

Fan Module Thermostat Switched Ball Bearing Long Life 50.000 Hours

Product Picture	Series	*Product Code and Description	Product Dimensions WxDxH mm
	Accessory	LN-FAN-ONF-1FWM-CC 1 fan units on/off switched, wall mounting	346x145x50
		LN-FAN-ONF-2FWM-CC 2 fan units on/off switched, wall mounting	346x145x50
		LN-FAN-THM-1FWM-CC 1 fan units with thermostatic control unit, wall mounting	346x175x50
		LN-FAN-THM-2FWM-CC 2 fan units with thermostatic control unit, wall mounting	346x175x50

* CC= Color codification replace CC with BL for Black RAL 9005 Color and replace CC with LG for Light Grey RAL 7035 Color.

* Add UK notation at the end of part number, example LN-FAN-ONF-1FWM-BL-UK for UK BS1363 plug.

Fan Module Thermostat Switched Ball Bearing Long Life 50.000 Hours - Economic

Product Picture	Series	*Product Code and Description	Product Dimensions WxDxH mm
	Aksesuar	LN-FAN-BB-1FPR-CC 1 way fan module on/off switched	140x170x40
		LN-FAN-BB-2FPR-CC 2 way fan module on/off switched	340x140x40
		LN-FAN-BB-1FPT-CC 1 way fan module thermostatic control unit	140x205x40
		LN-FAN-BB-2FPT-CC 2 way fan module thermostatic control unit	340x175x40

* CC= Color codification replace CC with BL for Black RAL 9005 Color and replace CC with LG for Light Grey RAL 7035 Color.

* Add UK notation at the end of part number, example LN-FAN-THM-1FWM-BL-UK for UK BS1363 plug.

Economic Extendable Modules Fan Modules- No Any Metal Housing Ball Bearing Long Life Fan - 50.000 Hours Economic +

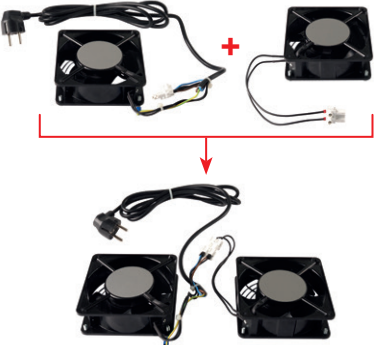
Product Picture	Series	Part Number and Product Description	Dimensions WxDxH mm
	Accessory	LN-FAN-HL-1FBB-M Single fan with grill, 1,8 meter power cable DIN 49441 schuko plug and extension terminal male, ball bearing long life fan	346x175x50
		LN-FAN-HL-1FBB-E Single fan with grill, extension terminal female ball bearing long life fan	346x175x50

* LN-FAN-HL-1FBB-E is just a fan for making cabinet equipped with 2 fans, used with main product LN-FAN-HL-1FBB-M and add the extension fan.

* Add UK notation at the end of part number, example LN-FAN-HL-1FBB-M-UK for UK BS1363 plug.

19" PROlineB Series

Wall Mounting Cabinets

Accessories

Snap in and Quick Terminal Grounding Cable Kit			
Product Picture	Series	*Product Code and Description	Product Dimensions WxDxH mm
	Accessory	LN-PRB-TPR-01 Snap in 3 pcs grounding terminals and 3 pcs 20 cm long plug in type yellow green grounding cables	-

19" PROlineB Wall Mounting Cabinet Assembly and Load Test Videos

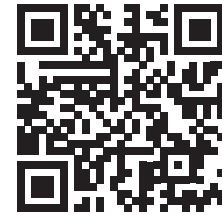
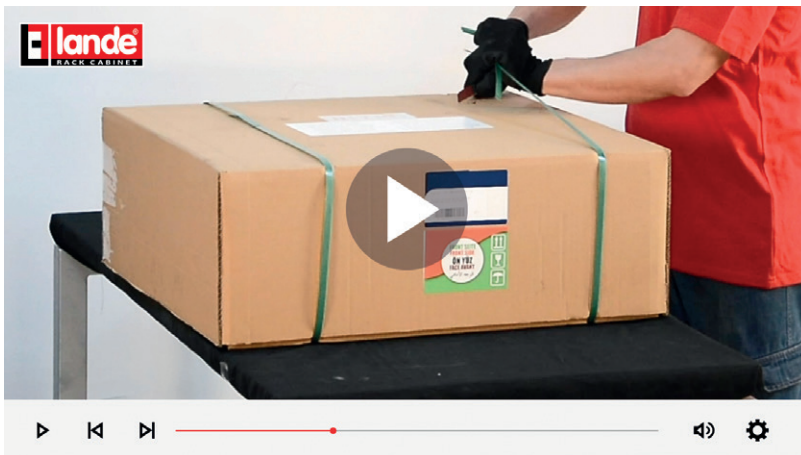

<https://youtu.be/-hro59Ds2k0>



CONTACT DETAILS

Headquarters

Address:

Merve Mah. Gazi Cad.
No: 17 34791 Sancaktepe
İstanbul / TÜRKİYE

Phone: +90 216 312 26 53

Fax : +90 216 312 09 09

Factory

Address:

20. Cadde No: 14 Eskişehir
Organize San. Bölğ. 26250
Eskişehir / TÜRKİYE

Phone: +90 222 236 24 66 pbx

Fax : +90 222 236 13 53

www.lande.com.tr | sales@lande.com.tr

