

## 19" DYNAMIC Basic Free Standing Cabinets

Width: 600 mm.  
Depth: 1000 mm.

Width=600mm  
Depth=1000mm

Standard Heights:

2 different U heights:  
26U, 42U

Standards, and Compliances:



**ISO 9001:2008**  
Quality Management System

EN 61587 -1:2012  
Mechanical Structures for  
Electronic Equipment

IEC 297-1, 19" mounting  
IEC 297-2 Overall cabinet dimensions



**CE conform to**  
EN 60950-1:2006  
Information Technology  
Equipment – Safety – Part-1-  
General Requirements



**Environment Friendly;**  
\*ISO 14001 Environmental  
Management System  
\*Environmental awareness  
\*RoHS compliancy  
\*% 100 Recyclable Material.

Load Capacity: 600 kgs.



DYNAMIC series Networking  
Enclosures, with 19" w:600mm  
and d:1000mm physical sizes,  
with max internal usable depth and  
2 different heights.

**Standard Colors:**



RAL 9005 Black



RAL 7035 Light Grey

# 19" DYNAMIC Basic Cabinets

W:600mm D:1000mm Drawings

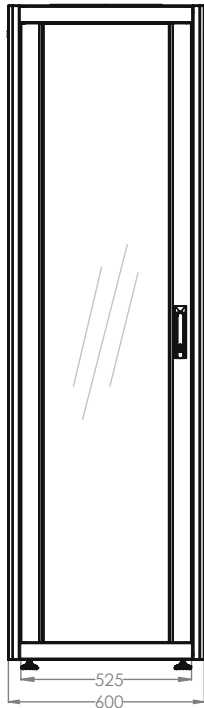
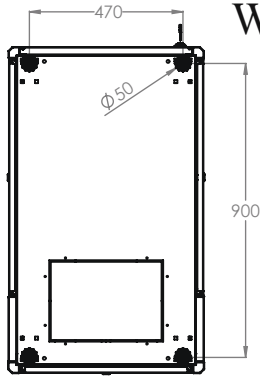

FRONT VIEW

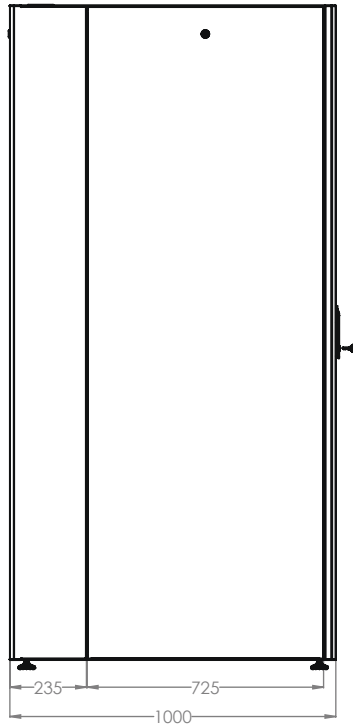

SIDE VIEW

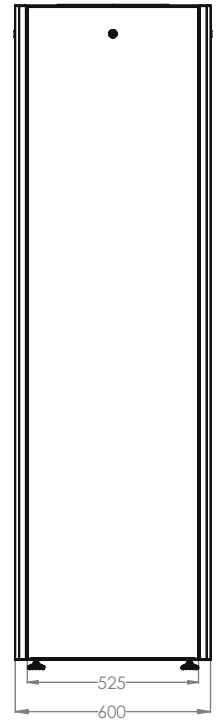

REAR VIEW

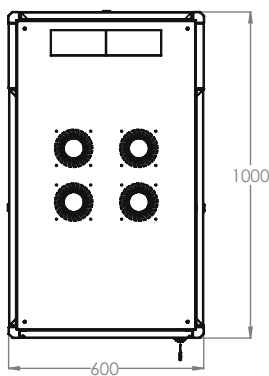

TOP VIEW

# 19" DYNAmic Basic Cabinets W:600mm D:1000mm Drawings

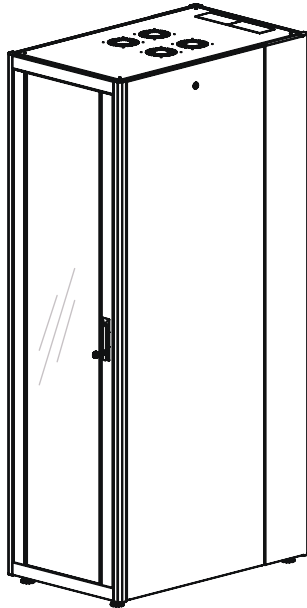

ISOMETRIC VIEW

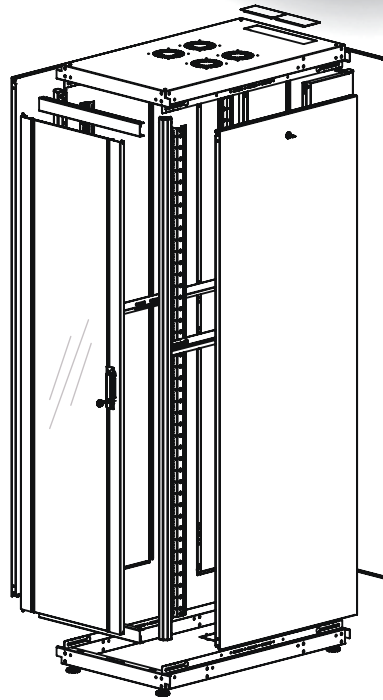

EXPLODED VIEW

Removable large cable entry panel connected with microjoints.

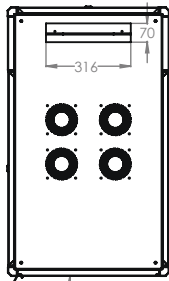

FRONT DOOR OPENING ANGLE

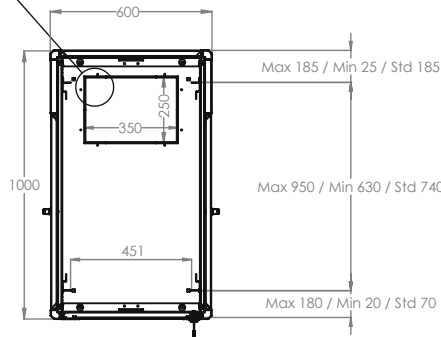

MAX/STD/MIN EQUIPMENT MOUNTING DISTANCE

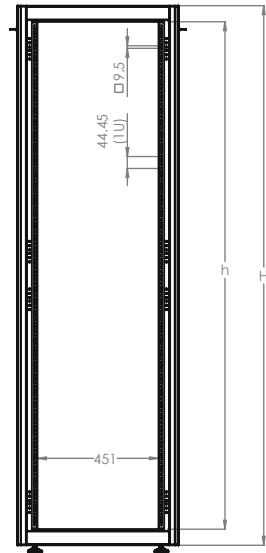

DIMENSIONS IN WIDTH AND HEIGHT

**DYNAmic Basic Series Free Standing 19" Cabinets W=600mm D=1000mm**

ROOT Product Number ***	Product Description	Size WxDxH mm	HU size (U)	HU in mm	* H mm, overall without feet and/or castor	Width Overall mm	Width Rail to Rail mm	Depth Overall mm	**Depth Shipping Conf. Rail to Rail mm	QTY IN PACKAGE	ASSEMBLED PACKAGE DIMENSIONS WxDxH	Standard NET Weight of product kgs	Gross Weight of Products kgs
LN-DB26U6010-CC	26U 19" Free Standing Cabinet W=600mm D=1000mm Glass front, panel style rear	600x1000x1300	26U	1155	1300	600	19"	1000	770	1	680x680x1440	61	71
LN-DB42U6010-CC	42U 19" Free Standing Cabinet W=600mm D=1000mm Glass front, panel style rear	600x1000x2010	42U	1867	2010	600	19"	1000	770	1	680x680x2150	96	108

\* Please add 30mm to H mm once used with Leveling Feet, add 80mm to H mm once used with castor set. \*\* See min and max Adjustable depth variations on drawings.

\*\*\* CC= LG for Light Grey RAL 7035 & BL for Black RAL 9005 for customers to define while ordering.

\*\*\*\* Unless defined delivery is in Flat Pack, Please add A notation to The Part number for assembled delivery ie. LN-DB26U6010-CC-A

\*\*\*\*\* The Logistical information provided in above chart is based on assembled product since packing details of flat-pack is changing based on transport vehicle and the delivery location. Please consider delivery notes, packing lists and recent data provided with the logistics services of Landé.